

(4N38(Short))

- AC LINE / DIGITAL LOGIC ISOLATOR.
- DIGITAL LOGIC/DIGITAL LOGIC ISOLATOR.
- TELEPHONE LINE RECEIVER.
- TWISTED PAIR LINE RECEIVER.
- HIGH FREQUENCY POWER SUPPLY FEEDBACK CONTROL.
- RELAY CONTACT MONITOR.

The TOSHIBA 4N38 (Short) through 4N38 (Short) consists of a gallium arsenide infrared emitting diode coupled with a silicon phototransistor in a dual in-line package.

- Switching Speeds : $3\mu\text{s}$ (Typ.)
- DC Current Transfer Ratio : 100% (Typ.)
- Isolation Resistance : $10^{11}\Omega$ (Min.)
- Isolation Voltage : 2500Vrms (Min.)
- UL Recognized : UL1577, File No. E67349

Unit in mm

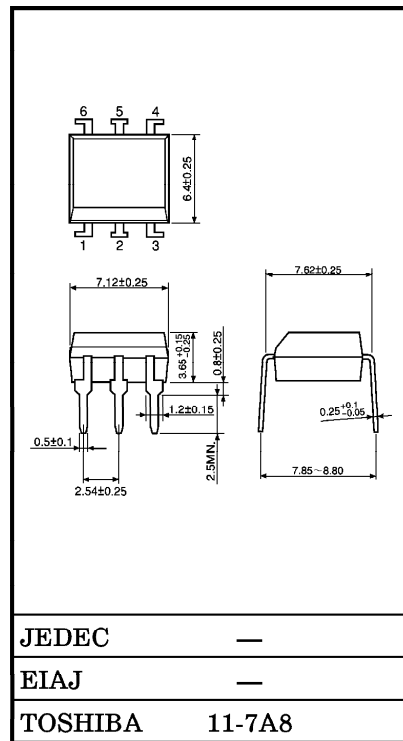

PIN CONFIGURATIONS (TOP VIEW)

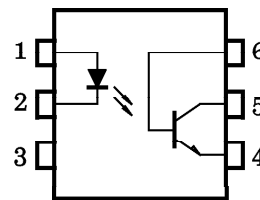

- 1 : ANODE
- 2 : CATHODE
- 3 : NC
- 4 : EMITTER
- 5 : COLLECTOR
- 6 : BASE

© The information contained herein is presented only as a guide for the applications of our products. No responsibility is assumed by TOSHIBA CORPORATION for any infringements of intellectual property or other rights of the third parties which may result from its use. No license is granted by implication or otherwise under any intellectual property or other rights of TOSHIBA CORPORATION or others.

© These TOSHIBA products are intended for use in general commercial applications (office equipment, communication equipment, measuring equipment, domestic appliances, etc.). please make sure that you consult with us before you use these TOSHIBA products in equipment which requires extraordinarily high quality and/or reliability, and in equipment which may involve life threatening or critical application, including but not limited to such uses as atomic energy control, airplane or spaceship instrumentation, traffic signals, medical instrumentation, combustion control, all types of safety devices, etc. TOSHIBA cannot accept and hereby disclaims liability for any damage which may occur in case the TOSHIBA products are used in such equipment or applications without prior consultation with TOSHIBA.

①

(4N38(Short))

MAXIMUM RATINGS (Ta = 25°C)

CHARACTERISTIC		SYMBOL	RATING	UNIT
LED	Forward Current (Continuous)	I _F	80	mA
	Forward Current Derating	ΔI _F /°C	1.07*	mA/°C
	Peak Forward Current (Note)	I _{PF}	3	A
	Power Dissipation	P _D	150	mW
	Power Dissipation Derating	ΔP _D /°C	2.0*	mW/°C
	Reverse Voltage	V _R	3	V
DETECTOR	Collector-Emitter Voltage	BV _{CEO}	80	V
	Collector-Base Voltage	BV _{CBO}	80	V
	Emitter-Collector Voltage	BV _{ECO}	7	V
	Collector Current (Continuous)	I _C	100	mA
	Power Dissipation	P _C	150	mW
	Power Dissipation Derating	ΔP _C /°C	2.0*	mW/°C
COUPLED	Storage Temperature	T _{stg}	-55~150	°C
	Operating Temperature	T _{opr}	-55~100	°C
	Lead Soldering Temperature (at 10s)	T _{sold}	260	°C
	Total Package Dissipation	P _T	250	mW
	Total Package Power Dissipation Derating	ΔP _T /°C	3.3*	mW/°C

Note : Pulse width 300μs, 2% duty cycle.

* Above 25°C ambient.

(4N38(Short))

ELECTRICAL CHARACTERISTICS (Ta = 25°C)

CHARACTERISTIC		SYMBOL	TEST CONDITION	MIN.	TYP.	MAX.	UNIT	
LED	Forward Voltage	V _F	I _F = 10mA	—	1.15	1.5	V	
	Reverse Current	I _R	V _R = 3V	—	—	100	μA	
	Capacitance	C _D	V = 0, f = 1MHz	—	30	—	pF	
DETECTOR	DC Forward Current Gain	h _{FE}	V _{CE} = 5V, I _C = 500μA	—	200	—	—	
	Collector-Emitter Breakdown Voltage	V _{(BR)CEO}	I _C = 1mA	80	—	—	V	
	Collector-Base Breakdown Voltage	V _{(BR)CBO}	I _C = 100μA	80	—	—	V	
	Emitter-Collector Breakdown Voltage	V _{(BR)ECO}	I _E = 100μA	7	—	—	V	
	Collector Dark Current	I _{CEO}	V _{CE} = 60V	—	1	50	nA	
	Collector Dark Current	I _{CBO}	V _{CB} = 60V	—	0.1	20	nA	
	Collector-Emitter Capacitance	C _{CE}	V = 0, f = 1MHz	—	10	—	pF	
COUPLED	Current Transfer Ratio	I _C / I _F	I _F = 10mA, V _{CE} = 10V	10	100	—	%	
	Collector-Emitter Saturation Voltage	V _{CE(sat)}	I _F = 20mA, I _C = 4mA	—	—	1.0	V	
	Capacitance Input to Output	C _S	V _S = 0, f = 1MHz	—	0.8	—	pF	
	Isolation Resistance	R _S	V _S = 500V, R.H. ≤ 60%	10 ¹¹	—	—	Ω	
	Isolation Voltage	BV _S *	BV _S	AC, 1 minute	2500	—	—	V _{rms}
			4N38A	AC, Peak	1500	—	—	V _{pk}
					2500	—	—	
	4N38A	AC, 1 second	1775	—	—	V _{rms}		
Turn-on Time	t _{on}	V _{CE} = 10V, I _C = 2mA R _L = 100Ω	—	3	—	μs		
Turn-off Time	t _{off}		—	3	—			

* JEDEC registered minimum BV_S, however, TOSHIBA specifies a minimum BV_S of 2500V_{rms}, 1 minute.

(4N38(Short))

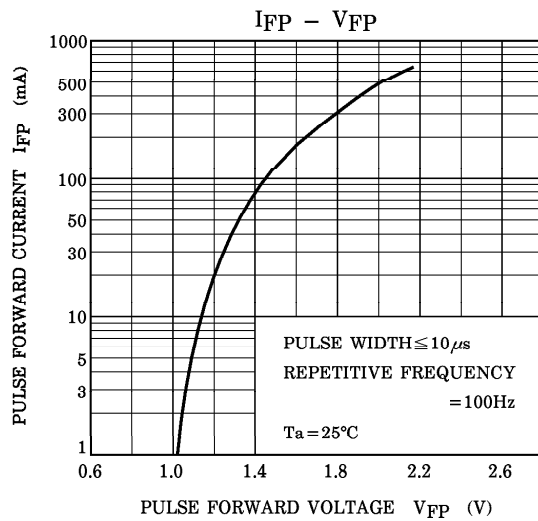
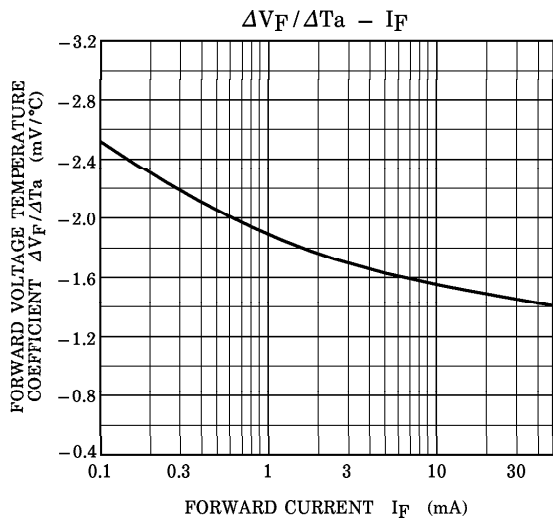
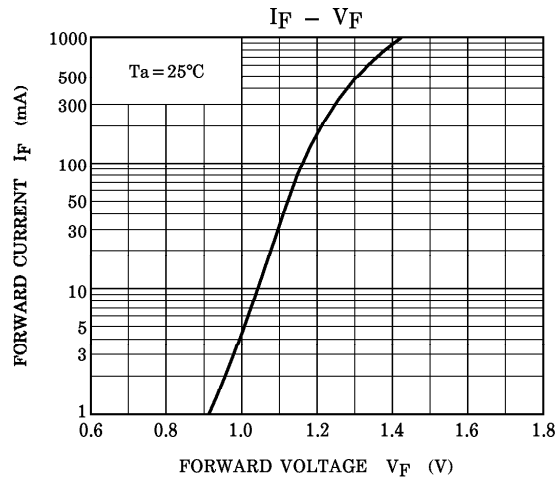
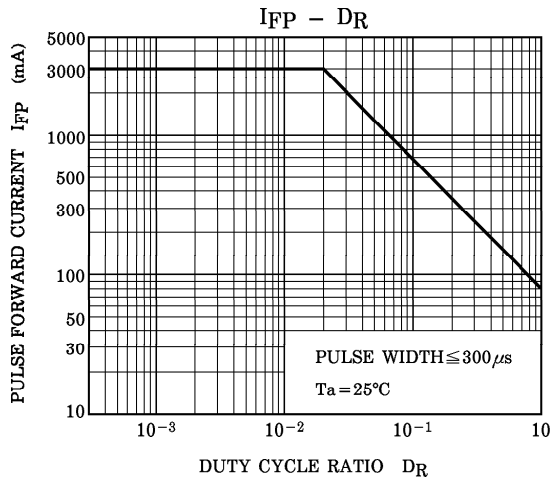
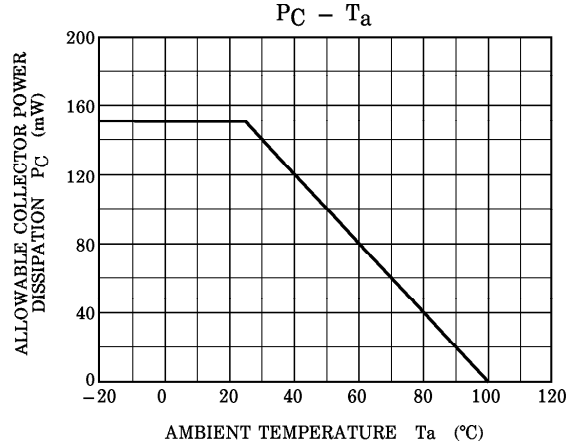
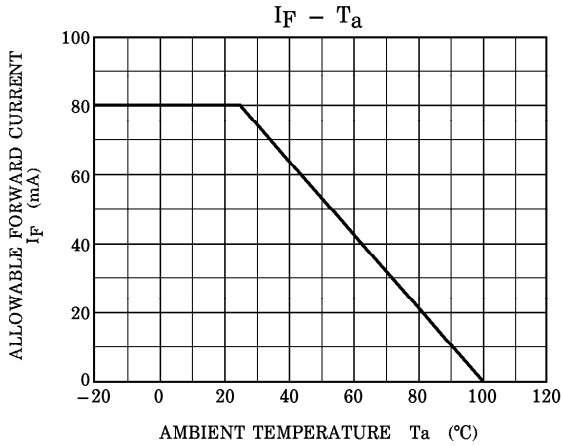

(4N38(Short))

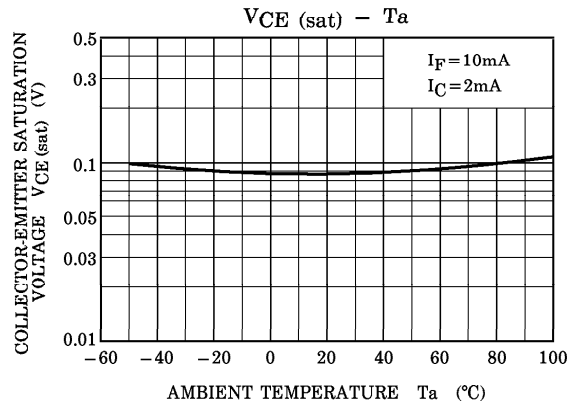
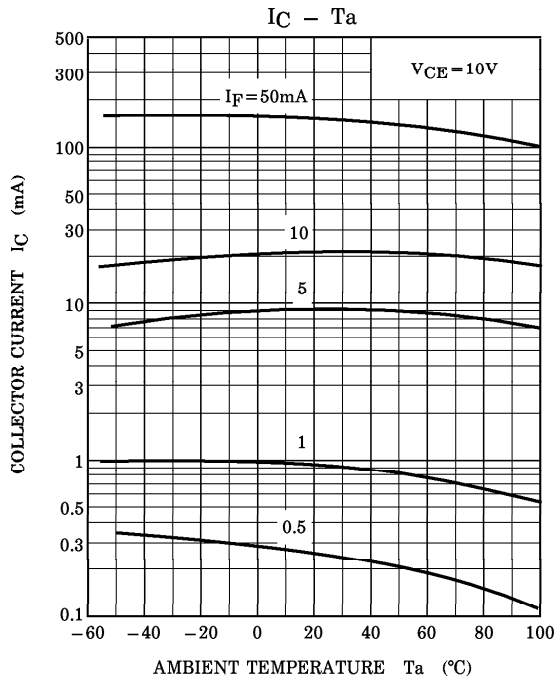
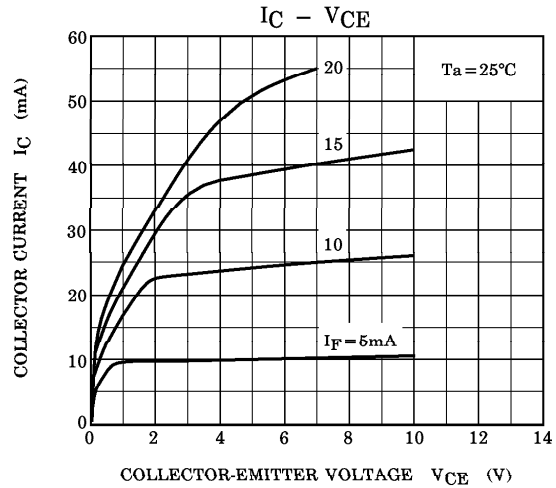
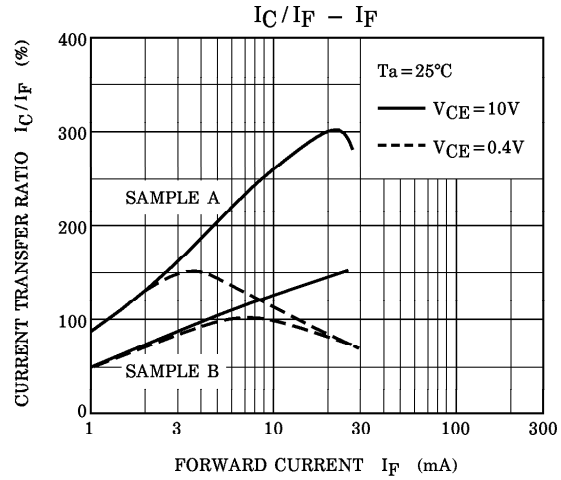
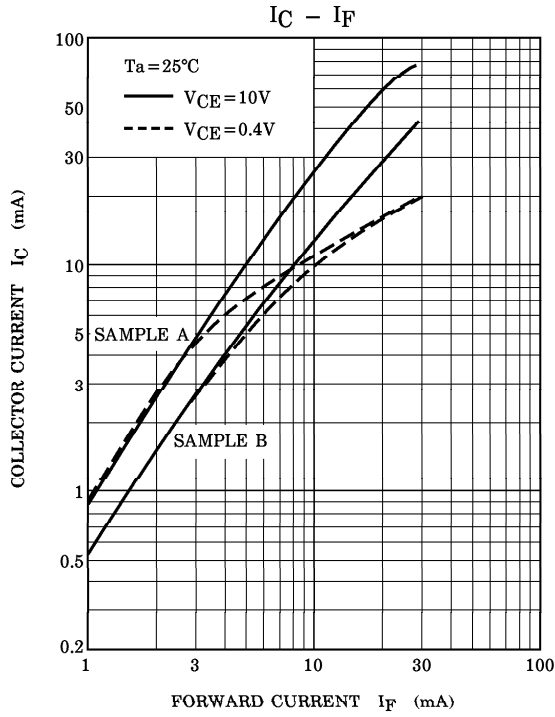

(4N38(Short))

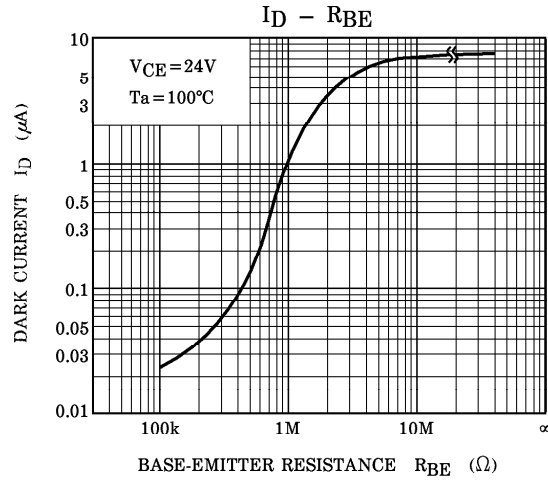
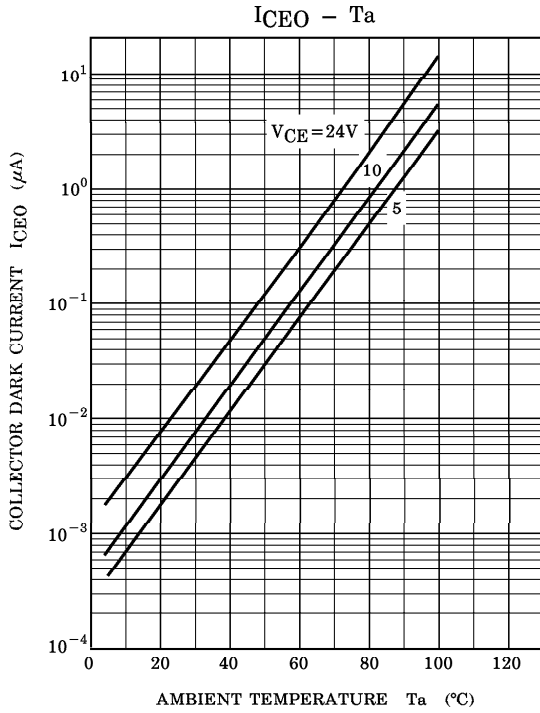

**SWITCHING CHARACTERISTICS - R_{BE}
 (SATURATED OPERATION)**

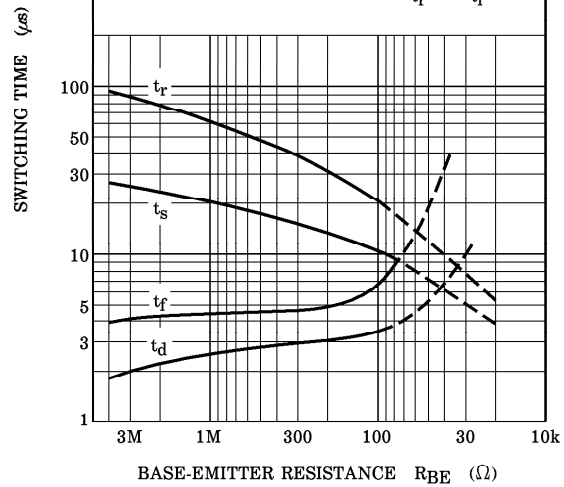
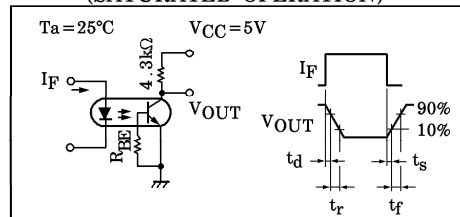

**SWITCHING CHARACTERISTICS - R_L
 (SATURATED OPERATION)**

